

# Montage / Installation

## Schall-Ex GS-8 / GS-10 einseitig / single actuation

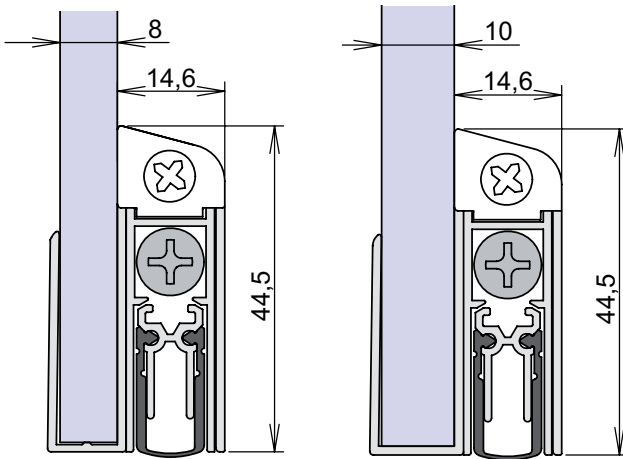

Lässt niX durch.  
DICHTUNGSSYSTEME FÜR  
TÜREN UND TORE



[www.athmer.de](http://www.athmer.de)  
[www.athmer.de](http://www.athmer.de)  
[www.athmer.de](http://www.athmer.de)

### Athmer

Sophienhammer  
59757 Arnsberg-Müschede

Tel. +49 2932 477-500  
Fax +49 2932 477-100

[info@athmer.de](mailto:info@athmer.de)  
[www.athmer.de](http://www.athmer.de)

# Kürzen / cutting to size



Lässt niX durch.  
DICHTUNGSSYSTEME FÜR  
TÜREN UND TORE

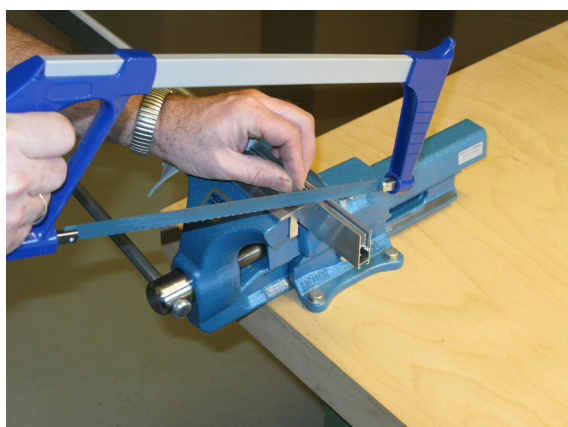
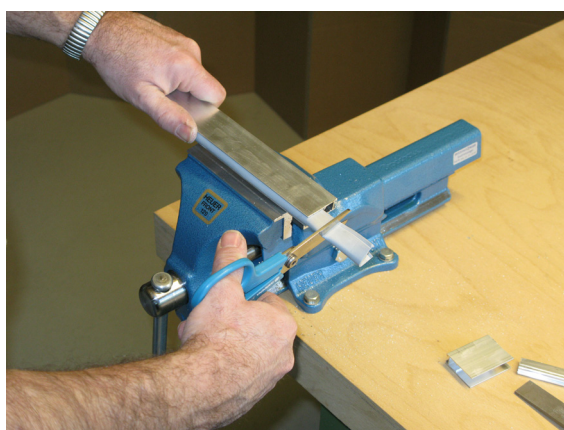
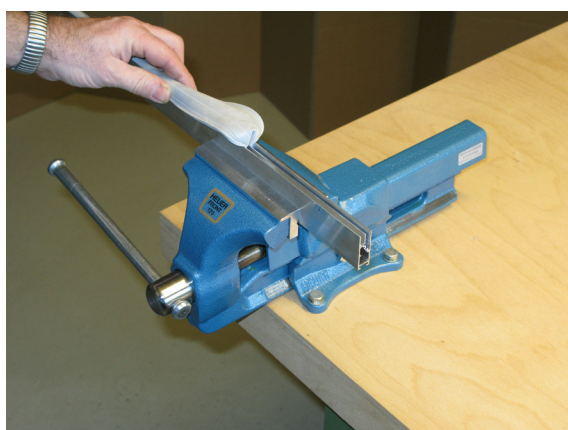
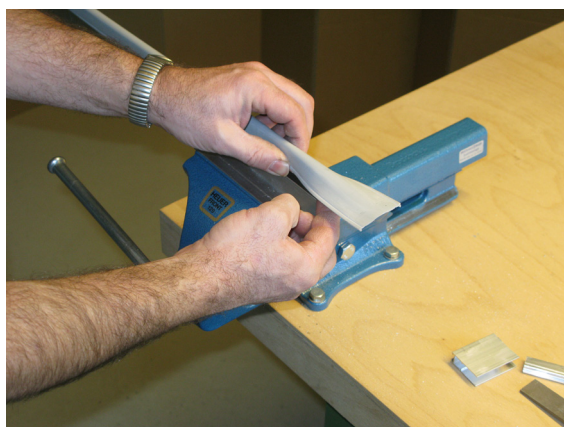
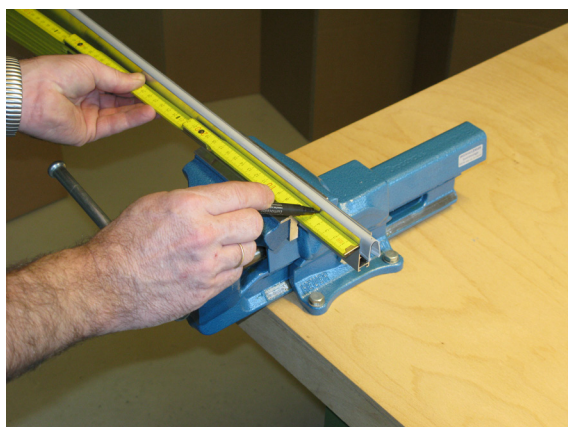

**Athmer** Sophienhammer  
59757 Arnsberg-Müschede

Tel. +49 2932 477-500  
Fax +49 2932 477-100

info@athmer.de  
www.athmer.de



# Kürzen / cutting to size



Lässt niX durch.  
DICHTUNGSSYSTEME FÜR  
TÜREN UND TORE

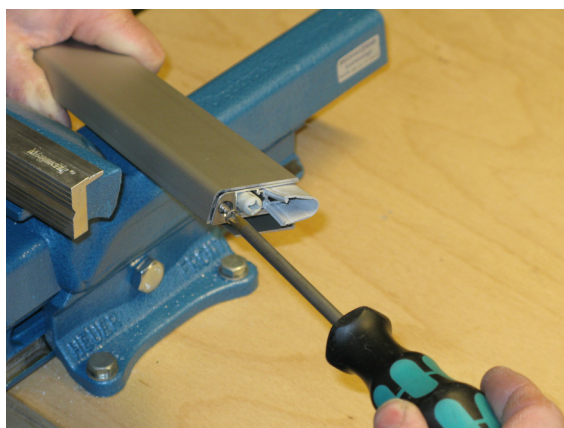
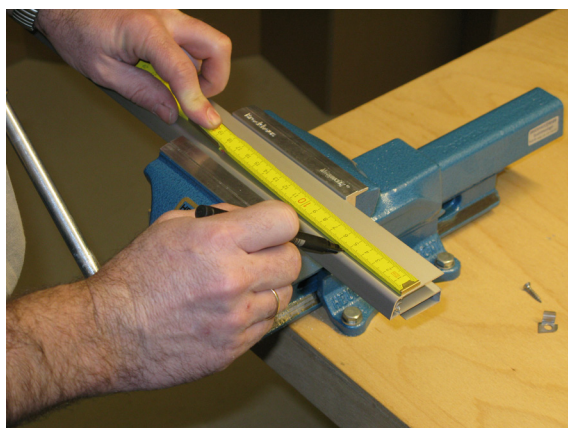
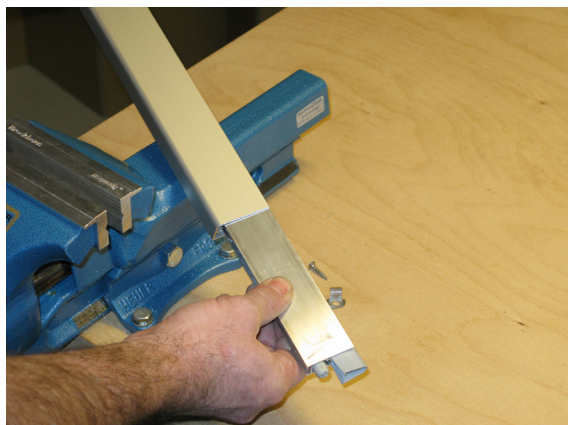
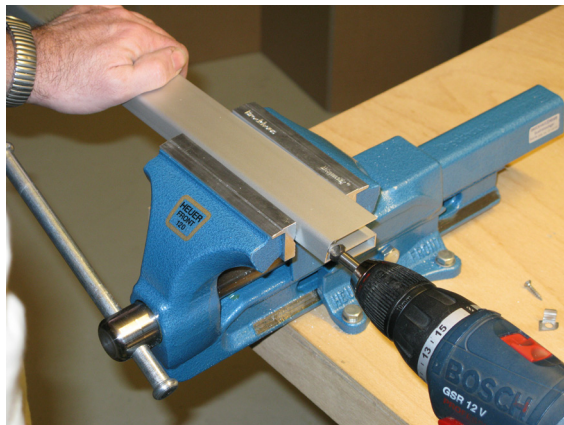
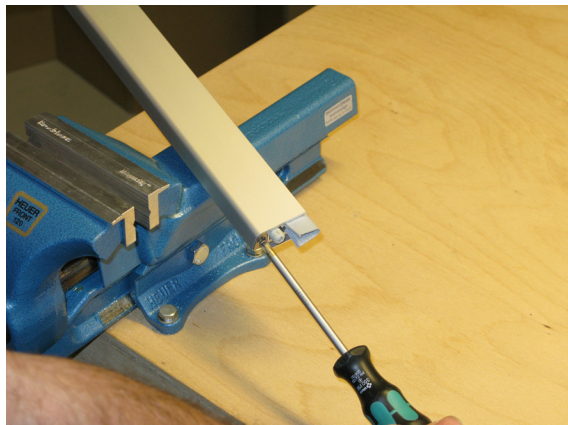

# Anschlag / fixing



Lässt niX durch.  
DICHTUNGSSYSTEME FÜR  
TÜREN UND TORE

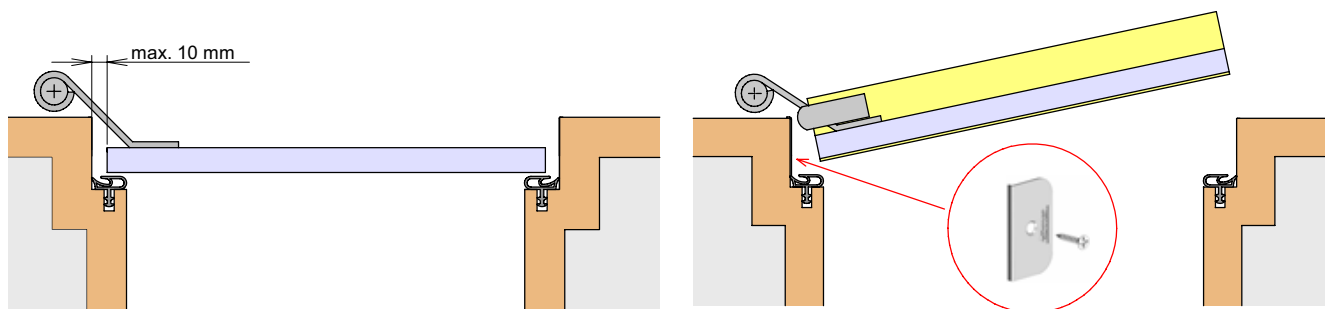

# Einstellen / adjustment



Lässt niX durch.  
DICHTUNGSSYSTEME FÜR  
TÜREN UND TORE

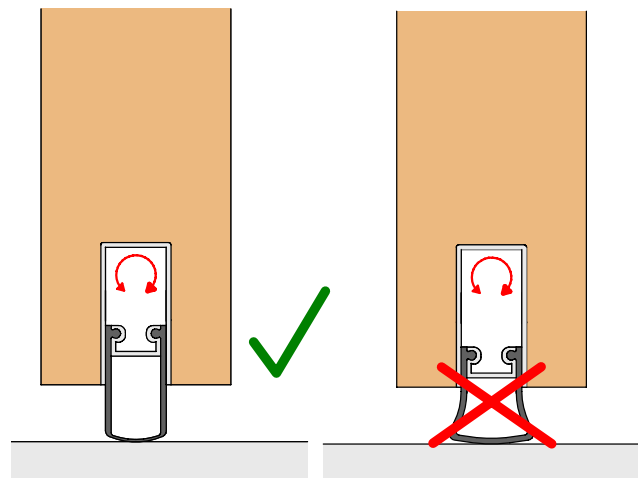
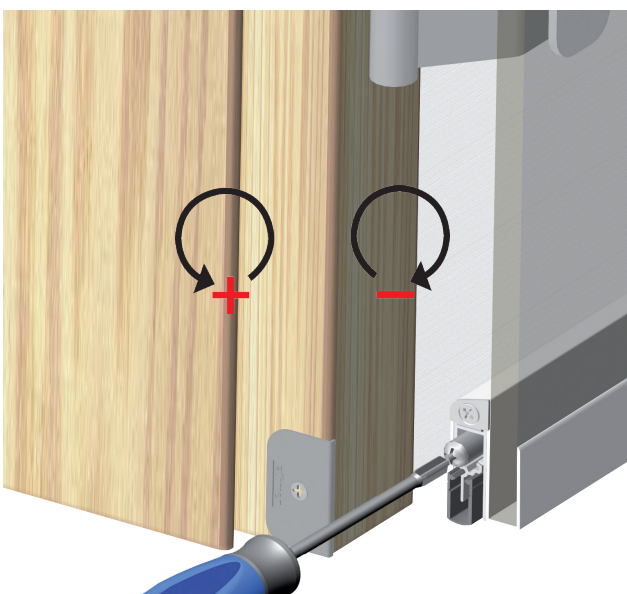
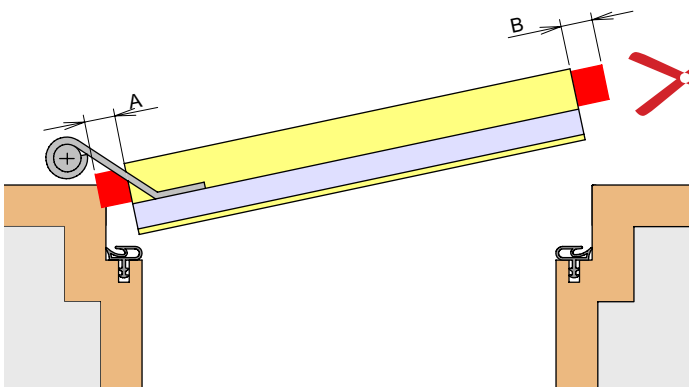
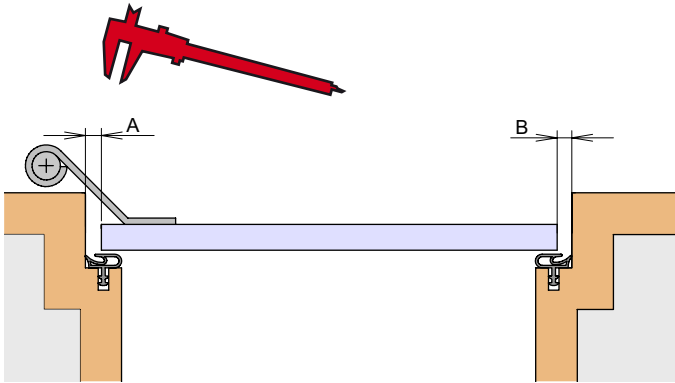

# Montage / Installation



Lässt niX durch.  
DICHTUNGSSYSTEME FÜR  
TÜREN UND TORE

## WECHSEL: DIN L - DIN R

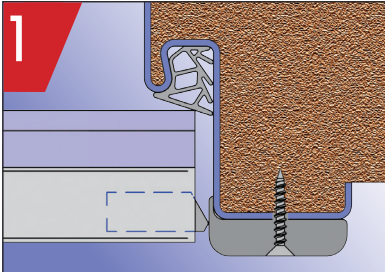

Option: Auflaufsockel

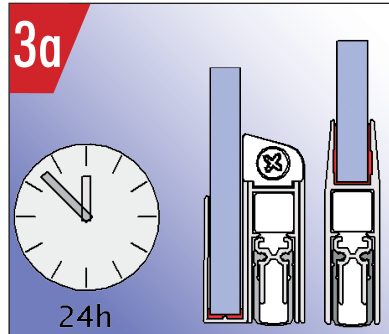
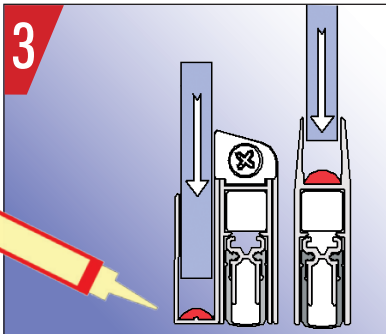
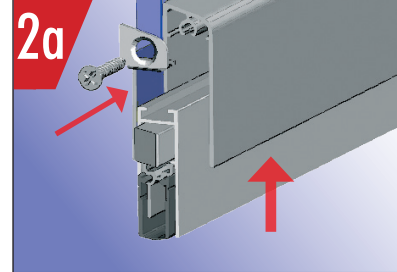
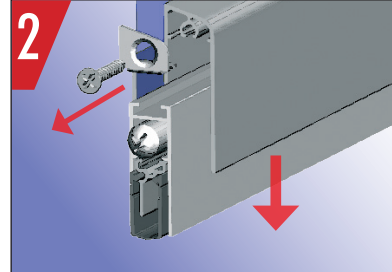

Bei VSG nur vom Glashersteller  
zugelassene Kleber und Dichtstoffe verwenden.